

Tous droits strictement réservés. Reproduction ou communication à des tiers interdite sous quelque forme que ce soit sans autorisation écrite du propriétaire. Propriété de c.FCI. Droits de reproduction FCI.

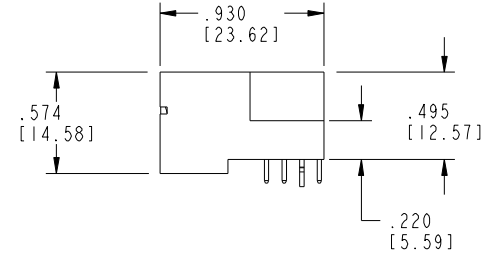

All rights strictly reserved. Reproduction or issue to third parties in any form whatever is not permitted without written authority from the proprietor. Property of FCI. Copyright FCI.

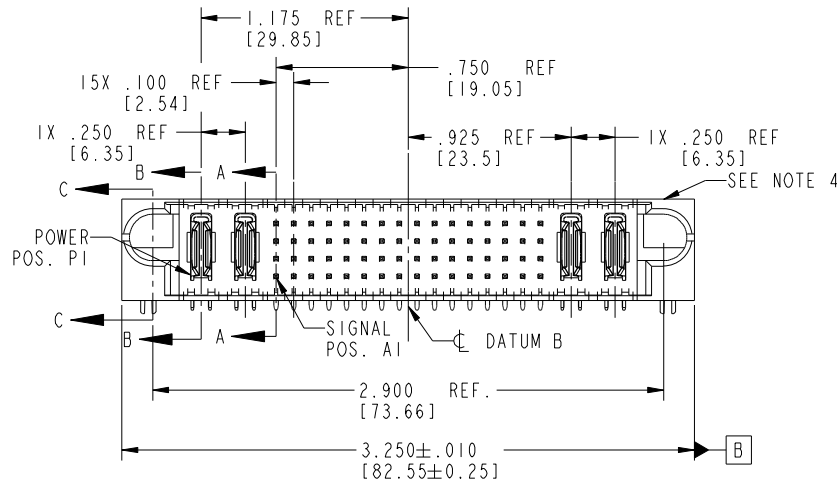
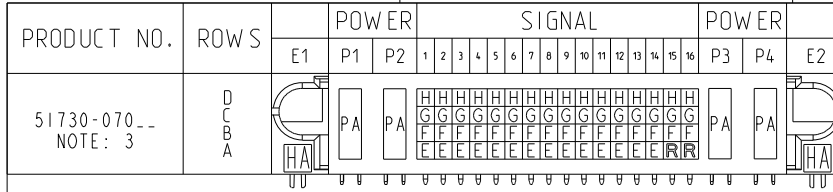

CODE	DIM "M" MATING LENGTH	CONTACT TYPE
PA	N/A [N/A]	POWER
HA	N/A [N/A]	HOLD-DOWN
H	.220 [5.59]	SIGNAL
G	.220 [5.59]	SIGNAL
F	.220 [5.59]	SIGNAL
E	.220 [5.59]	SIGNAL
R	.270 [6.86]	SIGNAL

mat'l code SEE NOTE 2				tolerances unless otherwise specified		CUSTOMER		www.fciconnect.com	
ltr	ecn no.	dr	date	linear	.XX±.01/0.X±0.3	COPY		title	
A	V03-0094	TAB	01/23/03		.XXX±.005/0.XX±0.13	projection		2P + 64S + 2P	
B	V03-0185	MEM	2/12/03	angles	.XXX±.002/0.XX±0.051			RIGHT ANGLE SOLDER HEADER	
C	DG05-0501	GuoJM	11/24/05		0°±2°			product family PwrBlade code 213	
D	DG08-0253	SH	09/13/08	dr	T. BRUNGARD 01/23/03	scale 1:1		size dwg no 51730-070 sheet 1 of 4	
				enrg	M. MOSTOLLER 01/23/03				
				chr	M. MOSTOLLER 01/23/03				
				appd	M. MOSTOLLER 01/23/03				
sheet index	revision sheet	D 1	D 2	D 3	D 4				

1 | 2 | 3 | 4
 Pro/E cage code 22526

Tous droits strictement réservés. Reproduction ou communication à des tiers interdite sous quelque forme que ce soit sans autorisation écrite du propriétaire. Propriété de c.FCI. Droits de reproduction FCI.

All rights strictly reserved. Reproduction or issue to third parties in any form whatever is not permitted without written authority from the proprietor. Property of FCI. Copyright FCI.

PRODUCT NUMBER
51730-070--
NOTE: 3

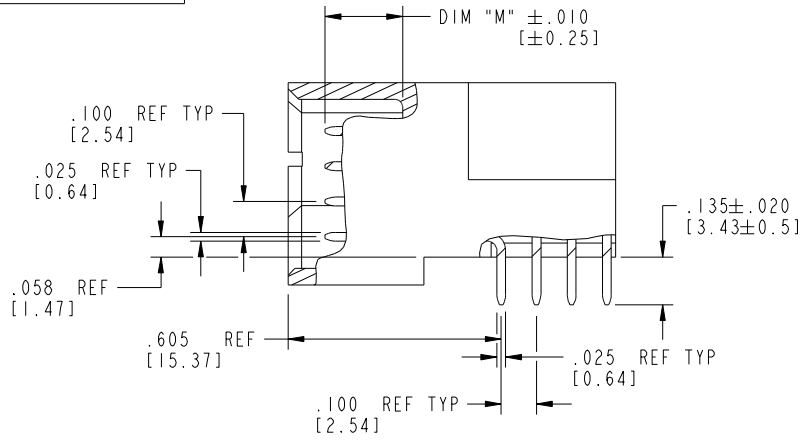

BROKEN-OUT SECTION A-A
SCALE 2:1

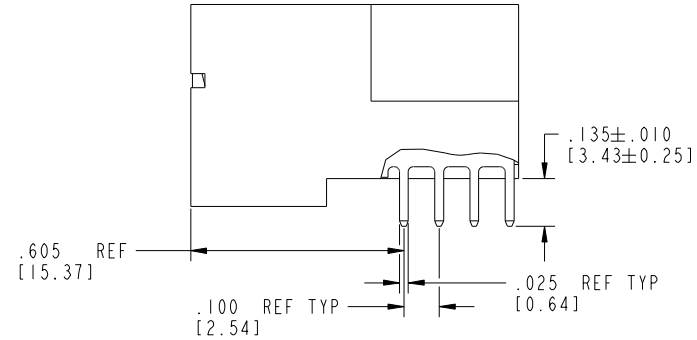

BROKEN-OUT SECTION B-B
SCALE 2:1

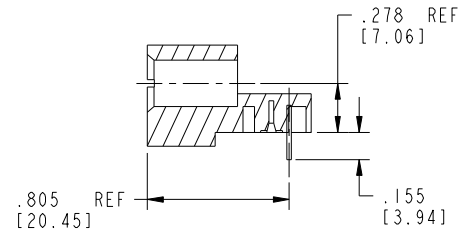

SECTION C-C

mat'l code		SEE NOTE 2		tolerances unless otherwise specified		CUSTOMER		FCI		www.fciconnect.com	
litr	ecn no.	dr	date	linear	.XX±.01/0.X±0.3	COPY		projection		title	
D					.XXX±.005/0.XX±0.13	INCH/MM		2P + 64S + 2P		RIGHT ANGLE SOLDER HEADER	
				angles	.XXX±.0020/0.XXX±0.051	scale		product family		code	
				dr	0°±2°	1:1		PwrBlade		213	
				enrg	T. BRUNGARD 01/23/03			size		sheet	
				chr	M. MOSTOLLER 01/23/03			dwg no		2 of 4	
				appd	M. MOSTOLLER 01/23/03			A		51730-070	
sheet index	revision sheet										

cage code 22526

Pro/E

Tous droits strictement réservés. Reproduction ou communication à des tiers interdite sous quelque forme que ce soit sans autorisation écrite du propriétaire. Propriété de c.FCI. Droits de reproduction FCI.



All rights strictly reserved. Reproduction or issue to third parties in any form whatever is not permitted without written authority from the proprietor. Property of FCI. Copyright FCI.

PRODUCT NUMBER
51730-070__
NOTE: 3

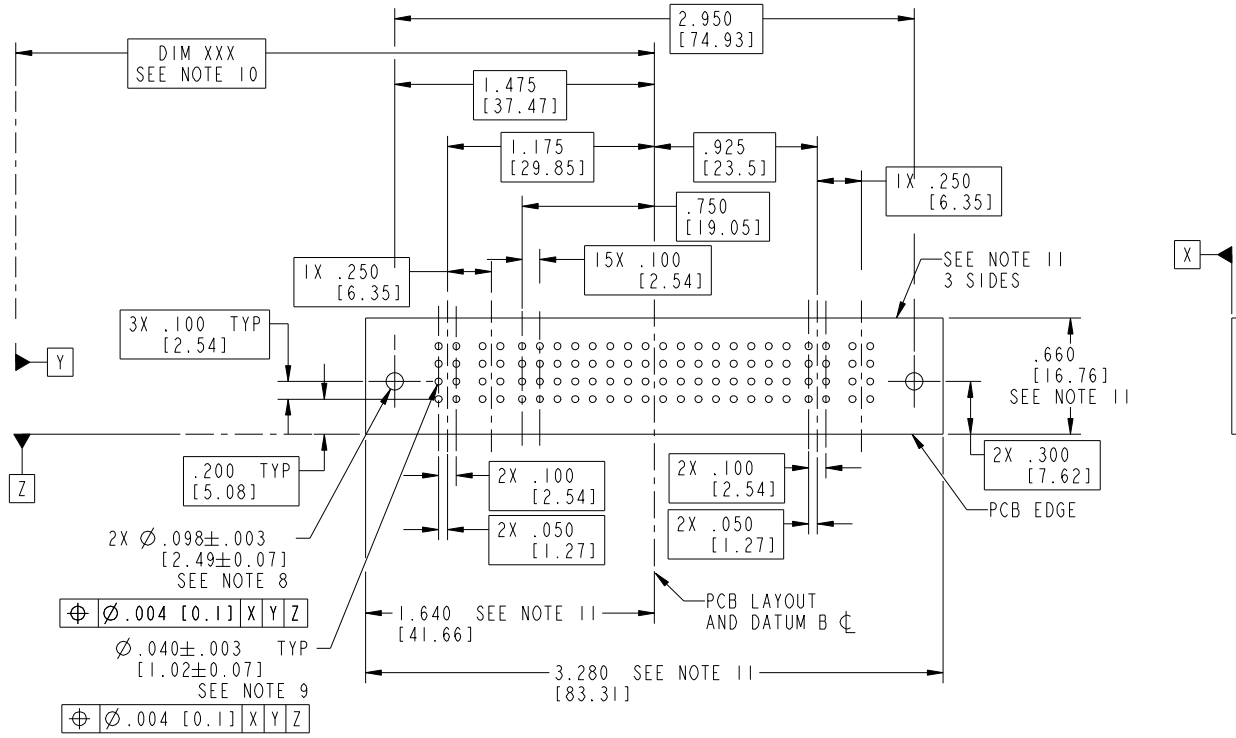

RECOMMENDED PCB LAYOUT

mat'l code		SEE NOTE 2		tolerances unless otherwise specified		CUSTOMER		 www.fciconnect.com	
ltr	ecn no.	dr	date	linear	.XX±.01/0.X±0.3	COPY		title	
D					.XXX±.005/0.XX±0.13	projection		2P + 64S + 2P	
				angles	.XXX±.0020/0.XXX±0.051			RIGHT ANGLE SOLDER HEADER	
				dr	0°±?	INCH/MM		product family	
				enrg	T. BRUNGARD 01/23/03	scale		PwrBlade	
				chr	M. MOSTOLLER 01/23/03	1:1		code	
				appd	M. MOSTOLLER 01/23/03	A		213	
sheet index	revision sheet							size	
								dwg no	
								51730-070	
								sheet	
								3 of 4	

cage code 22526

Pro/E

Tous droits strictement réservés. Reproduction ou communication à des tiers interdite sous quelque forme que ce soit sans autorisation écrite du propriétaire. Propriété de c.FCI. Droits de reproduction FCI.

All rights strictly reserved. Reproduction or issue to third parties in any form whatever is not permitted without written authority from the proprietor. Property of FCI. Copyright FCI.

PRODUCT NUMBER
51730-070__
NOTE: 3

NOTES:

1. DIMENSIONS AND TOLERANCES ARE IN ACCORDANCE WITH ASME Y14.5M, 1994 UNLESS OTHERWISE SPECIFIED.

CONNECTOR NOTES:

- 2. HOUSING MATERIAL: UL 94 V-0 GLASS FILLED
HIGH-TEMP THERMOPLASTIC
POWER CONTACT MATERIAL: COPPER ALLOY
SIGNAL PIN MATERIAL: COPPER ALLOY
 - 3. PLATING:
▲ SEE ITEM 1 & 2 IN PRINT 10064183 FOR PLATING SPEC OF 51730-070 AND 51730-070LF RESPECTIVELY
 - 4. MANUFACTURER'S NAME, P/N, AND DATE CODE TO APPEAR ON THIS SURFACE.
 - 5. PRODUCT SPECIFICATION GS-12-149.
APPLICATION SPECIFICATION BUS-20-067.
 - 6. PACKAGED IN TRAYS.
- PCB NOTES:
- 7. ALL HOLE DIAMETERS ARE FINISHED HOLE SIZE.
 - 8. MOUNTING HOLES, WHERE APPLICABLE, ARE UNPLATED.
 - 9. $\varnothing .0453 \pm .0010$ [1.151 ± 0.025] DRILLED HOLES PLATED WITH
.0003 [0.008] MIN SnPb OVER .001 [0.03]
TO .003 [0.08] Cu PLATING TO ACHIEVE
 $\varnothing .040 \pm .003$ [$1.02 \pm .07$] HOLE.
 - 10. "DIM XXX" TO BE DETERMINED BY THE CUSTOMER.
 - 11. CONNECTOR KEEP-OUT ZONE.
 - 12: A ▲ SYMBOL WILL BE NEXT TO ANY DIMENSION, VIEW, OR NOTE WHICH HAS BEEN MODIFIED WITH CURRENT DRAWING VERSION.

mat'l code		SEE NOTE 2		tolerances unless otherwise specified		CUSTOMER		FCI		www.fciconnect.com	
ltr	ecn no.	dr	date	linear	.XX±.01/0.X±0.3	COPY					
D					.XXX±.005/0.XX±0.13	projection		title 2P + 64S + 2P			
				angles	.XXX±.0020/0.XXX±0.051			RIGHT ANGLE SOLDER HEADER			
				dr	0°±?	INCH/MM		product family PwrBlade		code 213	
				enrg	T. BRUNGARD 01/23/03	scale		size dwg no		sheet 213	
				chr	M. MOSTOLLER 01/23/03	1:1		A 51730-070		4 of 4	
				appd	M. MOSTOLLER 01/23/03						
sheet index	revision sheet										

cage code 22526